



SCAN  
QR CODE  
TO WATCH  
VIDEO



# SEALING & BONDING SIKA PASSIVE FIRE PROTECTION SOLUTIONS



PROFESSIONAL  
FIRE PROTECTION

BUILDING TRUST





## SIKA SOLUTIONS TAME THE ELEMENT

Fire has been a fascinating element for thousands of years and many achievements in the history of mankind were only possible with its help. As much as controlled fire has been driving success and wealth, it equally has the power to hurt us – when out of control – and destroy achievements created over decades, within minutes. Therefore it is in everybody's interest not to lose control over this powerful and elementary force.

Sika provides comprehensive solutions where fire resistant construction is required such as commercial, public and residential buildings. Fire resistant sealants, fillers and backing materials for linear seals as well as solutions for penetration seals enable safer buildings and infrastructure to be built.

Our products comply with the latest relevant standards and can be used for a wide range of fire protection uses in linear seals, cavity barriers and penetration seals.

# CONTENTS

<b>05</b>	Sika Passive Fire Protection
<b>06</b>	Reaction to Fire and Resistance to Fire
<b>08</b>	Reaction to Fire and Resistance to Fire
<b>10</b>	Linear Seals and Service Penetration Seals
<b>13</b>	Intumescence and Intumescent Materials
<b>14</b>	Linear Seals, Field of Application
<b>16</b>	Flexible Walls and Rigid Walls
<b>17</b>	Classification of Linear Seals
<b>18</b>	Sika Passive Fire Protection
<b>22</b>	Sikasil®-670 Fire
<b>23</b>	Sikacryl®-621 Fire+
<b>25</b>	Sikacryl®-620 Fire
<b>26</b>	Sika® Backer Rod Fire
<b>27</b>	Sika Boom®-420 Fire
<b>29</b>	SikaSeal®-623 Fire+
<b>30</b>	Sikacryl®-625 Fire+
<b>31</b>	SikaSeal®-626 Fire Board+
<b>32</b>	SikaSeal®-627 Fire Collar+
<b>33</b>	SikaSeal®-629 Fire Wrap+
<b>34</b>	Sikacrete®-630 Fire+
<b>35</b>	SikaSeal®-632 Fire Putty+
<b>36</b>	Firespan Ablative Pads
<b>38</b>	Sika as a Solution Provider
<b>39</b>	Sikacrete®-213 F
<b>40</b>	Emseal Emshield WFR
<b>41</b>	Emseal Emshield DFR
<b>42</b>	Notes









# SIKA PASSIVE FIRE PROTECTION

Solutions that may save lives and protect property

Urbanisation – a much-debated megatrend – can be considered one of the key drivers of why passive fire protection is an increasingly important part of today's building industry: The more concentrated conditions and environments that we live in, the higher the risk of a life-threatening fire. Consistent use of integrated and effective passive fire protection is the most effective way to minimise this risk and protect people's life, their property and the environment.

Modern building frameworks are interspersed with multiple utility and network services including cables, pipes and ventilation ducts in both horizontal and vertical directions, resulting in countless penetrations through most of the walls and floors. Each of these penetrations and every joint between different building structures, elements and areas, is potentially a passage for the spread of flames, heat and toxic smoke into adjoining rooms and areas, which – in the worst case – may result in uncontrolled fire propagation throughout the entire building. This is where fire protection comes into play: Whilst active fire protection systems such

as sprinklers, can extinguish fires, **passive fire protection** is designed to prevent the spread of fire and contain it in defined compartments to minimise damage and – even more importantly – to allow people in other compartments time to evacuate safely. In the event of a fire, the heat and smoke will spread through penetrations and joints in the walls and floors, causing damage, endangering people and potentially also blocking escape routes.

Sika's passive fire protection solutions are designed to be able to seal all different types of building joints and penetrations, in order to help keep fire in defined compartments for a certain period of time, thereby allowing people to evacuate safely.

Sika passive fire protection solutions comply with the most relevant national and international standards (including EN, UL, EAD, ASTM, AS), in order to confirm that they meet the highest fire resistance requirements and consequently can help save people's lives.



# REACTION TO FIRE AND RESISTANCE TO FIRE

“Fire resistance testing” can be a very complex topic – the differences between ‘reaction to fire’ and ‘resistance to fire’ frequently causes confusion, but can be clarified as follows: **Reaction to fire** describes how a material contributes to the development and spread of a fire. Typically reaction to fire

is determined for a single material or product such as a wall covering or joint sealant, and not for a system or section such as a wall including the linear joints or penetrations. In Europe reaction to fire is classified according to European Standard EN 13501-1.

## REACTION TO FIRE

Euro class	Requirement	Examples of materials
A1	No contribution to fire	Stone, concrete, glass, most metals
A2	Insignificant contribution to fire	Similar to A1 including small amounts of organic compounds
B	No spread of fire and very limited contribution to fire	Gypsum boards with very thin surface covering, fire rated sealants
C	Very limited spread of fire	Gypsum boards with thicker surface coverings
D	Limited spread of fire	Wood & wooden products (depending on size)
E	Acceptable reaction to fire in case of a very small flame	Many plastic products and materials
F	Not passing requirements for classes A1-E	Other materials than classes A1-E







# REACTION TO FIRE AND RESISTANCE TO FIRE

**Resistance to fire** describes the ability of a building element to prevent the passage of heat and flames from one side to the other. Typically such building elements are walls or floors including joints and penetrations, windows and doors etc. This means that not only a specific material or product, but an entire system or building section has to be tested.

There are many different national and international test standards and classification schemes for fire resistance, however most of them follow the same principle: The building element or component for testing, including all of the service penetrations, joints, doors, windows and the joint sealant in and around them, is fixed into a test frame which is then attached to a test furnace. The side facing towards the furnace is known as the exposed or fire side, whilst the outer side is the unexposed or non-fire side. The furnace temperature is raised according to a defined curve reaching 945°C after 60 minutes and 1,153°C after 240 minutes. Two parameters are relevant for most fire resistance tests: Integrity and Insulation.

## E – Integrity

Integrity (E) is a building element's capability – when exposed to fire on one side – to prevent the passage of flames and hot gases to the unexposed side.



## I – Insulation

Insulation (I) is a building element's capability to maintain its thermal insulation function when exposed to fire on one side. Most standards allow a maximum of 180°C temperature rise on the unexposed side.

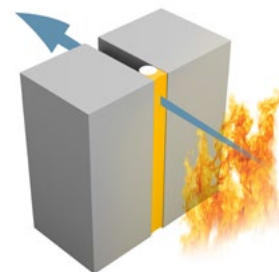

Standard	Description, Scope	Remark
EN 1366-3	Test standard for penetration seals	Most relevant standards for resistance to fire testing (Fire stopping) Also referred to in EAD and partly AS 1530.4
EN 1366-4	Test standard for linear joint seals	
EN 13501-2	Classification standard for linear joint seals and service penetration seals	Leading to EI classes. Relevant for EN 1366 and EAD
BS 476-20	Test standard for linear joint seals and service penetration seals	British standard; superseded by EN 1366/EN 13501 but still used in some regions
EAD 350454-00-1104	Fire stopping and fire sealing products – penetration seals	Leading to CE marking and DoP. Replaced ETAG 026 Fire resistance tested acc. EN 1366
EAD 350141-00-1106	Fire stopping and fire sealing products – linear joints and gap seals	
UL EU UL US/ULC	Certification scheme for product safety based in the US	Different test methods and requirements for different regions (e.g. UL EU and UL US/UL C)
AS 1530.4	Test and classification for linear joint seals and service penetrations	Australian standard, technically very similar to EN 1366
Certifire	Certification scheme for fire protection products	Relevant in the Middle East



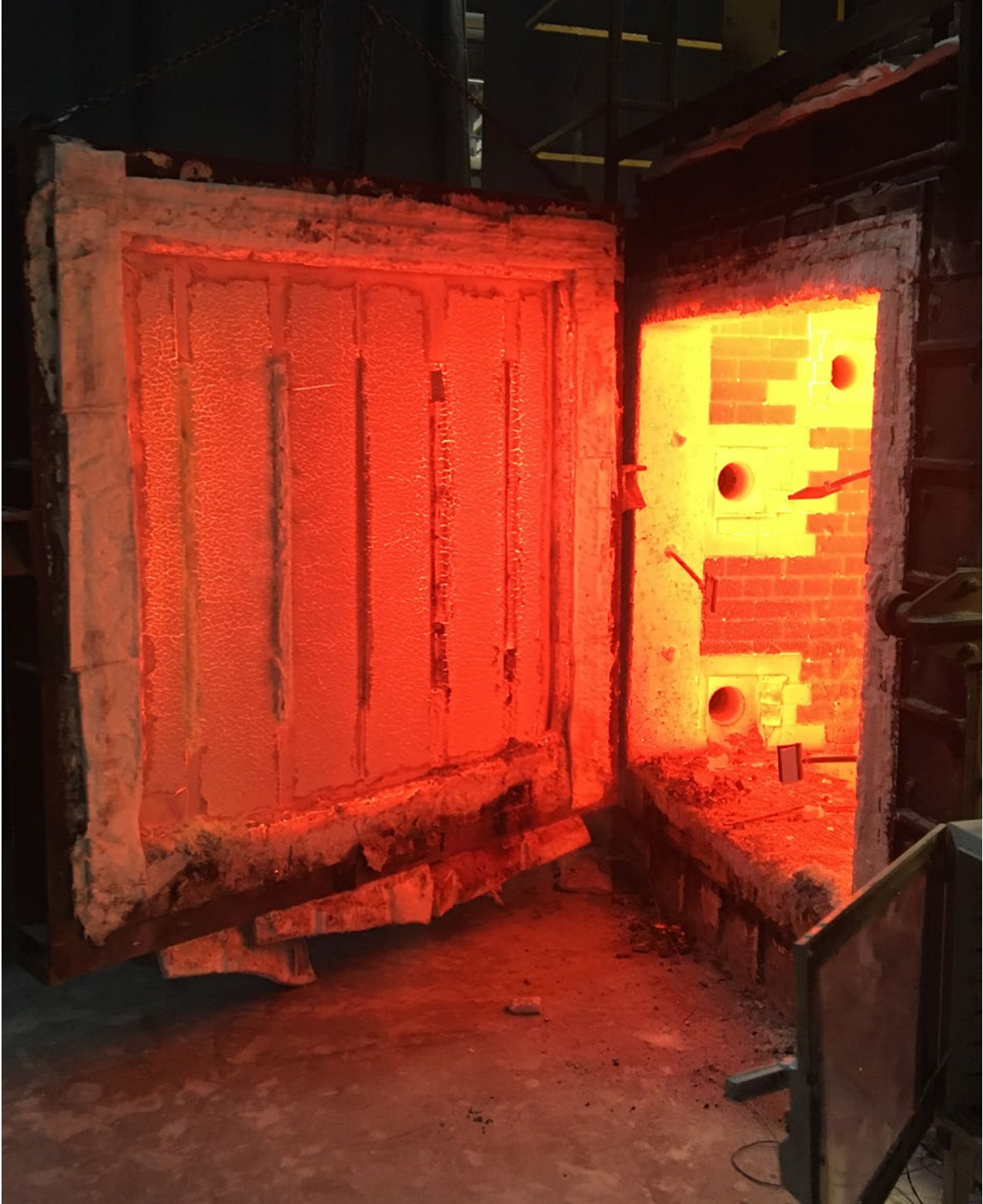

Furnace with vertical linear seals after resistance to fire test acc. EN 1366-4

# LINEAR SEALS AND SERVICE PENETRATION SEALS

Passive fire protection applications for compartmentations can be divided into the following two main groups:

- Linear joint seals
- Penetration seals

**Linear joint seals** are passive fire protection systems designed to maintain the required building fire resistance across a separating element plus, if and where relevant, to accommodate a defined degree of movement. Linear joint seals can be found in walls, floors and in so called head of wall applications – joints between wall and ceiling or wall and floor.

A fire resistant linear joint seal can be achieved by different approaches:

The most common way is to use a fire-resistant joint sealant in combination with a standard PE backing rod. In this case only the sealant is usually required to provide fire resistance while the backer rod is considered as sacrificial.

An alternative approach is to use a fire-resistant backer rod – typically based on an inorganic fire resistant material like mineral wool – and combine it with a standard joint sealant. In this case the fire resistance of the linear seal is provided by the backer rod and the joint sealant is used to accommodate limited movement, ensure water tightness and provide mechanical protection.

The 3<sup>rd</sup> option is to seal the joint with a fire-resistant expanding foam. This system is only recommended where the joints have very limited movement and are not exposed to water, UV radiation or mechanical impact.



PE backer rod and fire resistant sealant



Fire resistant backer rod and standard joint sealant



Fire resistant expansion foam





The following parameters have an influence on the fire resistance of a building element and hence of its classification. Therefore it is crucial to know all relevant details to select the right product.

- 1** Types of involved building material  
e.g. concrete/steel
- 2** Element orientation horizontal (floor)  
or vertical (wall)
- 3** Element thickness
- 4** Joint dimension (width, depth)
- 5** Joint configuration: Single seal exposed/  
unexposed, double seal
- 6** Expected joint movement



# LINEAR SEALS AND SERVICE PENETRATION SEALS

**Penetration seals** are passive fire protection systems designed to maintain the fire resistance of a building element or section – wall or floor – where services such as cables, cable trays, pipes or ventilation ducts pass through.

The vast number of different building materials and different services and the types of penetrations that can be required leads to a wide variety of different solutions for seals around these service penetrations. The result is that for most of these penetration sealing applications, several alternative solutions with different systems and products can be used – if the combination has been tested.

One of the challenges with sealing penetrations is that certain services (e.g. combustible pipes) will melt in the event of a fire, which results in even larger apertures that must be closed immediately. For this type of application, expanding intumescent materials are usually a very effective solution.





# INTUMESCENCE AND INTUMESCENT MATERIALS

Many passive fire protection products are claimed to be intumescent – what does this mean and when can a product be classified as intumescent?

An intumescent is a substance that expands as a result of heat exposure, thus increasing in volume and decreasing in density. Intumescent materials used in fire protection will increase their volume significantly under the influence of heat (starting at ~150°C). This physical process is one of the main principles for passive fire protection products: Intumescent products are able to close gaps in and around service penetration seals very quickly in the event of a fire.

These intumescent products are particularly useful for sealing combustible services like plastic pipes – which can melt and create larger openings in the building floors and walls – an important role in passive fire protection. However, not all passive fire protection products are highly intumescent; for instance flexible silicone joint sealants, acrylic sealants and some coated insulation boards are used for passive fire protection based on different chemical and/or physical principles.

Unfortunately at this time there is no clear definition of how much a material or product has to expand under heat in order to be classed as intumescent. This means that building owners and their professional construction team must take steps to check and confirm that the intumescent materials, systems and products selected, will perform and that their volume will expand sufficiently to seal the dimensions of any openings and gaps that could be created during a fire.

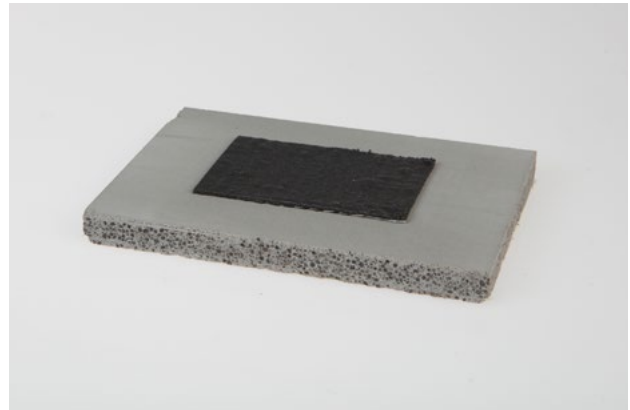

Highly intumescent, fire resistance wrap before (top) and after (bottom) exposure to heat

# LINEAR SEALS, FIELD OF APPLICATION

EN 1366-4 defines in which situation a tested linear seal orientation can be applied to other orientations in practical use. The tables below show a simplified version of these definitions.

In practice this means that vertical joints in walls (B) and horizontal joints in walls (C) are only covered if this specific orientation has been tested, whilst joints between ceilings and walls (D, head of walls) are covered by the testing of seals for joints in floors (A).

A	Linear joint in a horizontal test arrangement (floor)
B	Vertical linear joint in a vertical test arrangement (wall)
C	Horizontal linear joint in a vertical test arrangement (wall)
D	Horizontal wall joint abutting a floor, ceiling or roof (head of wall)

Tested orientation	Covered application(s)
A	A, C
B	B
C	C
D	C, D

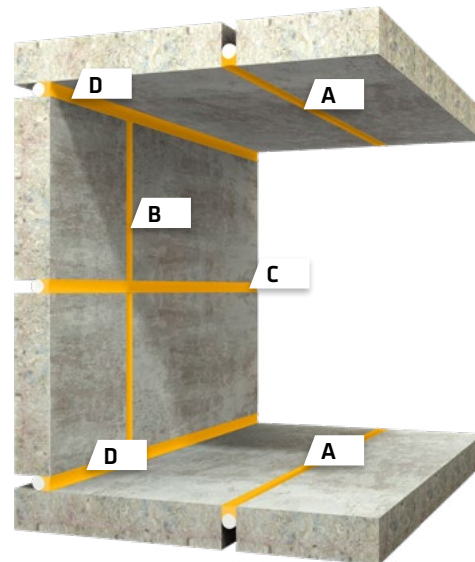

Horizontal floor joint abutting a wall.









# FLEXIBLE WALLS AND RIGID WALLS

In principle each type of structural element (walls or floors) will lead to a different fire resistance classification and consequently these have to be tested separately. For simplification EN 1363-1 defines two generic classes of walls; testing using one of them will cover a wider range of substrates than just the one tested. Thanks to this rule resources can be saved without compromising on safety.

Flexible wall substrates are lightweight gypsumboard faced steel or timber stud wall partitions made from defined materials and dimensions.

Rigid wall substrates consist of aerated concrete blocks produced with a consistent density of approx. 650 kg/m<sup>3</sup>.

Tests performed with these flexible wall substrates are suitable to cover all flexible walls of the same composition and the same or higher thickness, as well as rigid walls of the same or higher thickness. Tests performed on the rigid wall substrates are suitable to cover all rigid walls of the tested or higher thicknesses and of the tested or higher material densities (e.g. precast concrete instead of aerated concrete).

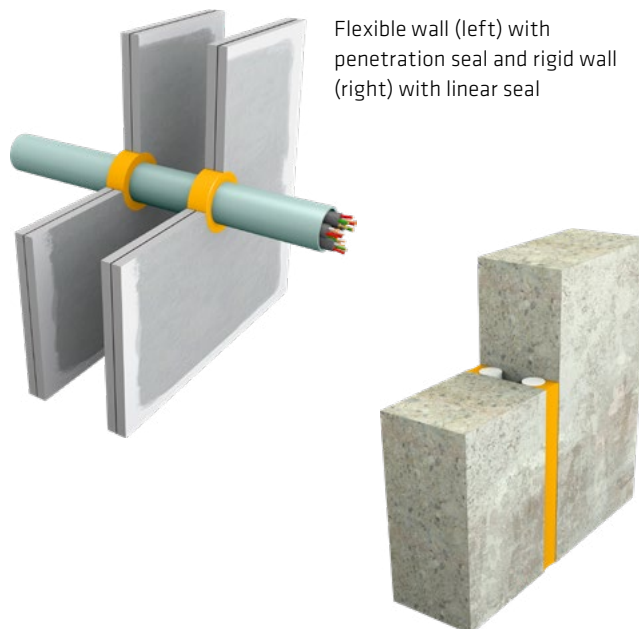



# CLASSIFICATION OF LINEAR SEALS

EN 13501-2 is the European classification standard for fire resistance of many building elements including linear seals and penetrations. The classification for linear seals provides information on 5 variable parameters, some of which are well

known, whilst others are used less frequently. The following chart gives an overview of this linear seal classification system including all of the available options.

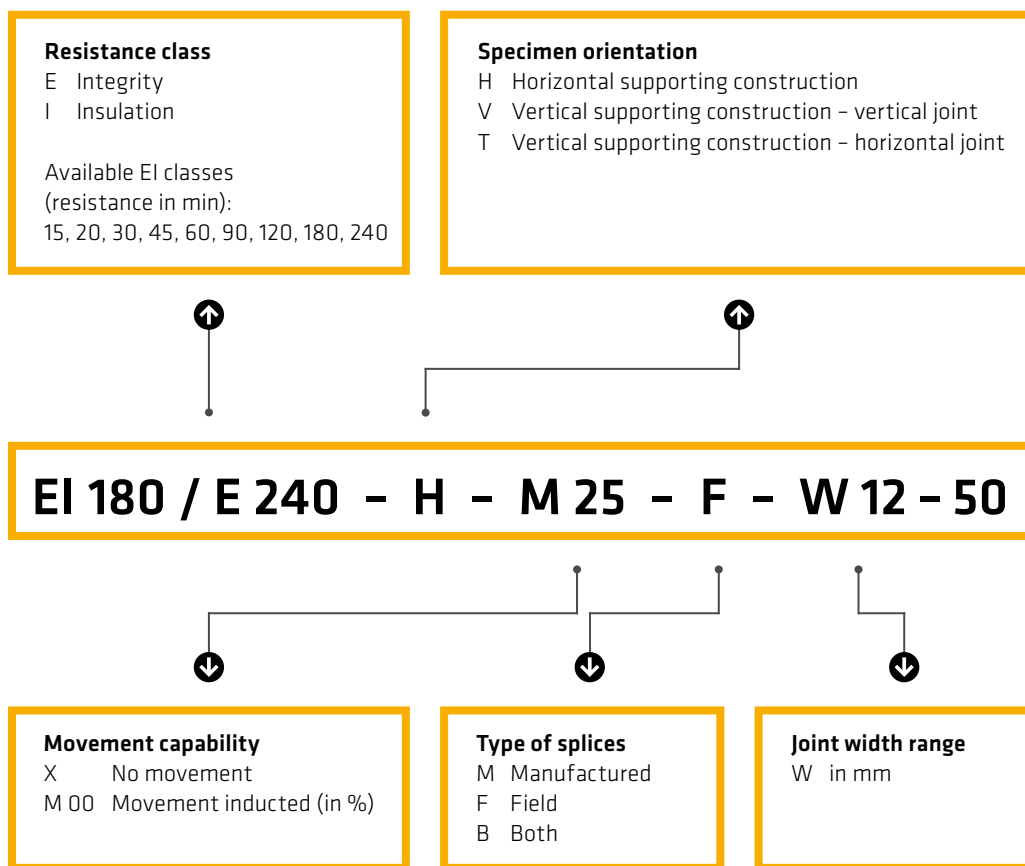

You may be asked the question: “Is your fire resistant joint seal able to accommodate movement?” Be careful! - It is not enough to use an elastic joint sealant with the required movement capability (e.g. according to ISO 11600 or ASTM C 920); because specific fire resistance tests (e.g. according to EN 1366-4) must also be performed under forced movement.

To do so the joint is mechanically stretched by the required amount (e.g. 25%) and direction before the fire resistance test, then kept at this position for the duration of the test. From the respective product’s EN 13501-2 classification you can see what degree of movement a product was tested with:

**EI 120 - V - X - F - W 0-30**

Joint classification without movement (X)

**EI 120 - V - M 25 - F - W 0-30**

Joint classification with 25% movement (M 25)

According to EAD 350141-00-1106 linear joint seals tested without movement can accommodate a maximum of 7.5% movement. Internal non-structural wall and floor jointing applications (e.g. construction, connection, daywork and isolation joints) typically do not call for more than of 7.5% movement capability.

# SIKA PASSIVE FIRE PROTECTION

Typical applications





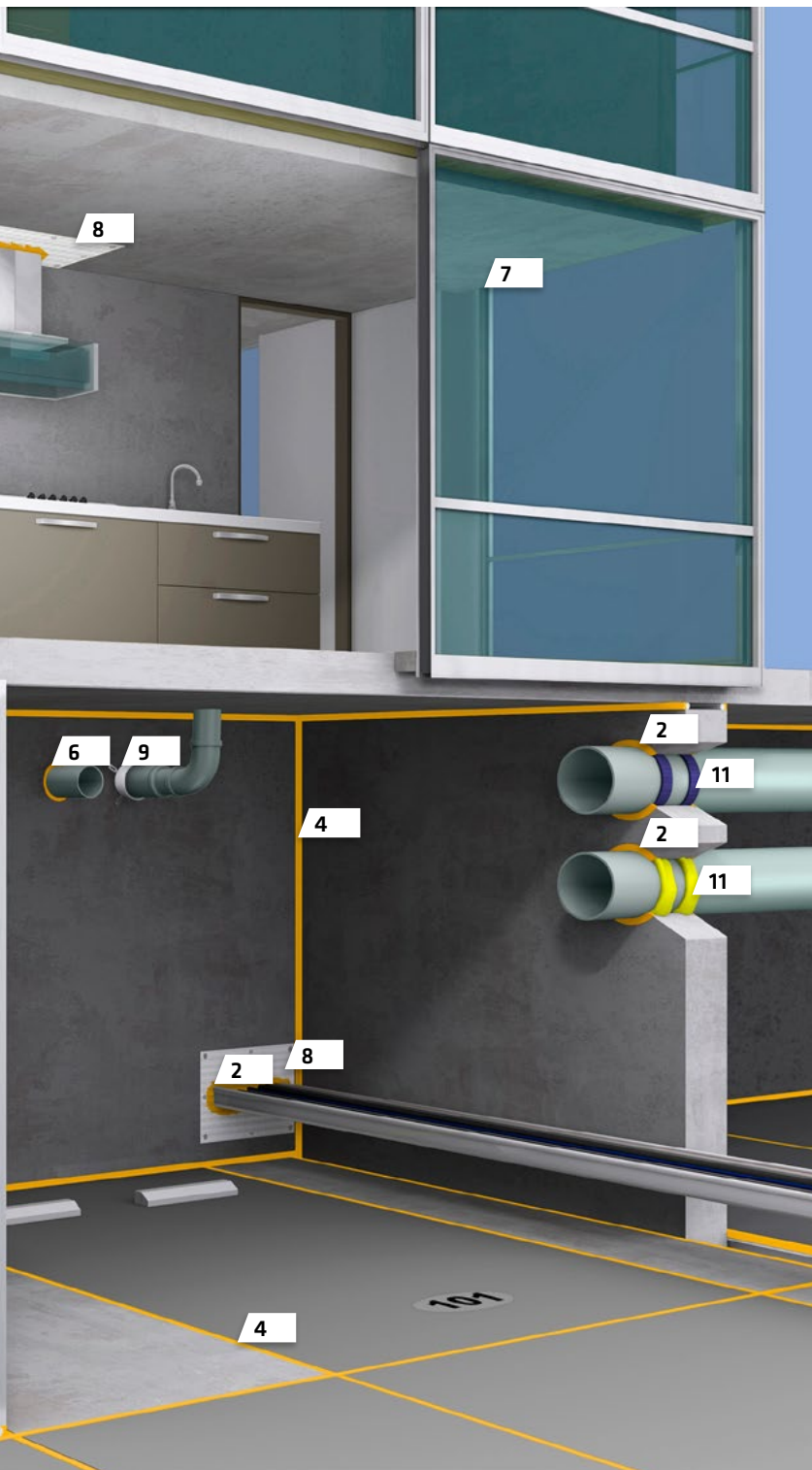

1

**Sikasil®-670 Fire**

Fire resistant silicone sealant for linear movement seals in walls and floors

7

**Sikacryl®-625 Fire+**

Fire resistant ablative coating for SikaSeal®-626 Fire Board+

2

**Sikacryl®-621 Fire+**

Fire resistant acrylic sealant for service penetration and joints

8

**SikaSeal®-626 Fire Board+**

Fire resistant coated protection board

3

**Sikacryl®-620 Fire**

Fire resistant acrylic sealant for linear seals

9

**SikaSeal®-627 Fire Collar+**

Fire resistant pipe collar

4

**Sika® Backer Rod Fire**

Fire resistant mineral wool based backer rod system for linear seals

10

**Sikacrete®-630 Fire+**

Fire resistant load bearing compound

5

**Sika Boom®-420 Fire**

Fire resistant PU expansion foam for linear seals

11

**SikaSeal®-629 Fire Wrap+**

Fire resistant pipe wrap

6

**SikaSeal®-623 Fire+**

Fire resistant intumescent sealant for penetration seals

12

**SikaSeal®-632 Fire Putty+**

Fire resistant putty cord

# SIKA PASSIVE FIRE PROTECTION

A full product range

1

**Sikasil®-670 Fire**  
Fire resistant silicone sealant for linear seals in walls and floors

2

**Sikacryl®-621 Fire+**  
Fire resistant acrylic sealant for service penetration and joint seals

3

**Sikacryl®-620 Fire**  
Fire resistant acrylic sealant for linear seals





4

**Sika® Backer Rod Fire**

Fire resistant mineral wool based backer rod system for linear seals

5

**Sika Boom®-420 Fire**

Fire resistant PU expansion foam for linear seals

6

**SikaSeal®-623 Fire+**

Fire resistant intumescent sealant for penetration seals

7

**Sikacryl®-625 Fire+**

Fire resistant ablative coating for SikaSeal®-626 Fire Board+

8

**SikaSeal®-626 Fire Board+**

Fire resistant coated protection board

9

**SikaSeal®-627 Fire Collar+**

Fire resistant pipe collar

10

**Sikacrete®-630 Fire+**

Fire resistant load bearing compound

11

**SikaSeal®-629 Fire Wrap+**

Fire resistant pipe wrap

12

**SikaSeal®-632 Fire Putty+**

Fire resistant putty cord



# Sikasil®-670 Fire

Fire resistant silicone sealant for linear seals in walls and floors



## Description

Sikasil®-670 Fire is a fire resistant, elastic, neutral curing silicone sealant for interior and exterior joints in walls and floors.

## Uses

- Movement and connections joints in fire compartments like stair cases, corridors etc. (walls, floors and head to wall)
- Connections between concrete and steel elements
- Connections between concrete and wooden elements

## Advantages

- Fire resistance tests up to 25% movement
- Tested and classified according to many different fire resistance standards
- Up to 4 hours fire resistance
- Good adhesion to most substrates
- Neutral curing
- 1-part, ready to use

## Approvals, Certificates

- ETA acc. EAD-350141-00-1106
- EN 1366-4
- EN 13501-2
- BS 476-20
- UL EU
- UL 2079
- Certifire
- EN 10140-2
- EN 15651-1, -4
- ISO 11600 F 25 LM
- ASTM C 920 class 25



Packaging	Colour	Article Code
300 ml Cartridge, 12 pc/box	Concrete Grey	582754
300 ml Cartridge, 12 pc/box	White	483479
600 ml Foil, 12 pc/box	Black	585146

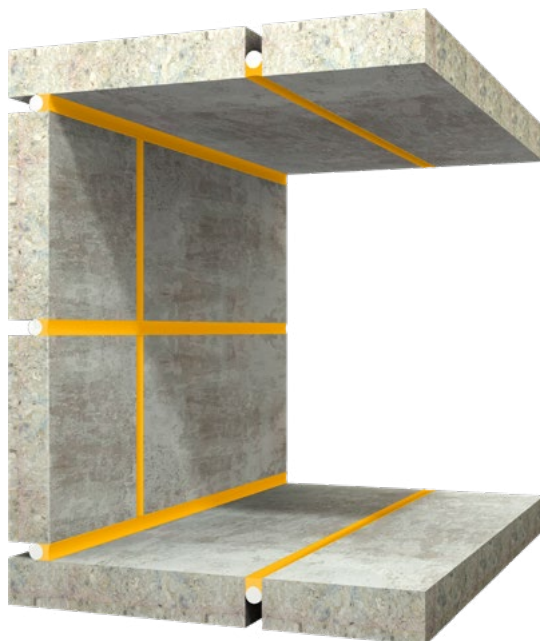



# Sikacryl®-621 Fire+

Fire resistant acrylic sealant for linear seals and penetrations



## Description

Sikacryl®-621 Fire+ is a fire resistant, intumescent, phthalate-free acrylic sealant used for interior joints and penetration seals in fire compartment walls and floors.

## Uses

Restores the fire resistance performance of a wall or floor which incorporates penetration services or linear seals

Can be used in combination with SikaSeal®-626 Fire Board+, SikaSeal®-627 Fire Collar+ and SikaSeal®-629 Fire Wrap+

## Advantages

- Up to 4 hours fire resistance
- 1-part ready to use, easy to apply
- Provides acoustic insulation
- Tested for a large variety of relevant wall and floor types

## Approvals, Certificates

- ETA acc. EAD-350141-00-1106
- ETA acc. EAD-350454-00-1104
- EN 1366-4, EN 1366-3
- EN 13501-2
- UL EU
- EN 10140-2
- Ecodecode EC1<sup>PLUS</sup>
- LEED Attestation



Packaging	Colour	Article Code
300 ml Cartridge, 12 pc/box	White	691174

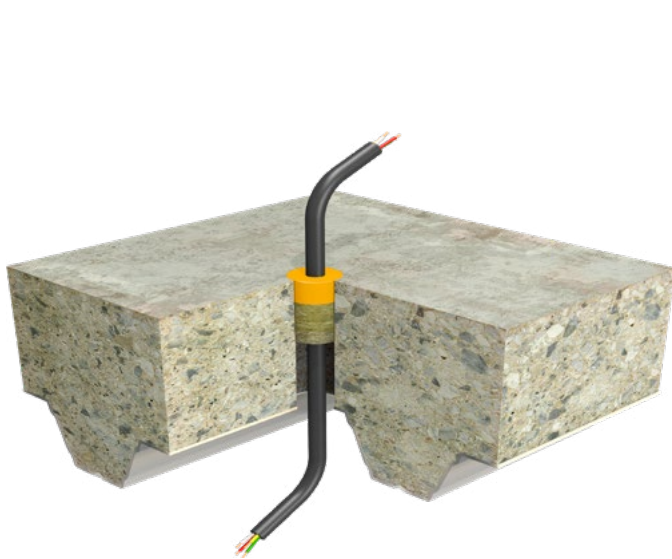





# Sikacryl<sup>®</sup>-620 Fire

Fire resistant acrylic sealant for linear seals



## Description

Sikacryl<sup>®</sup>-620 Fire is a fire resistant, acrylic sealant for interior joints in walls and floors.

## Uses

Connection joints in fire compartments like stair cases (walls, floors and head to wall)

Connections between concrete and steel elements

Connections between concrete and wood elements

## Advantages

Tested and classified according to many different fire resistance standards

Ready to use, easy to apply, easy to clean

Up to 4 hours fire resistance

## Approvals, Certificates

ETA acc. EAD-350141-00-II06

EN 1366-4

EN 13501-2

BS 476-20

UL 2079

Certifire

EN 10140-2

EN 15651-1

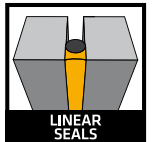

Packaging	Colour	Article Code
300 ml Cartridge, 12 pc/box	White	483461

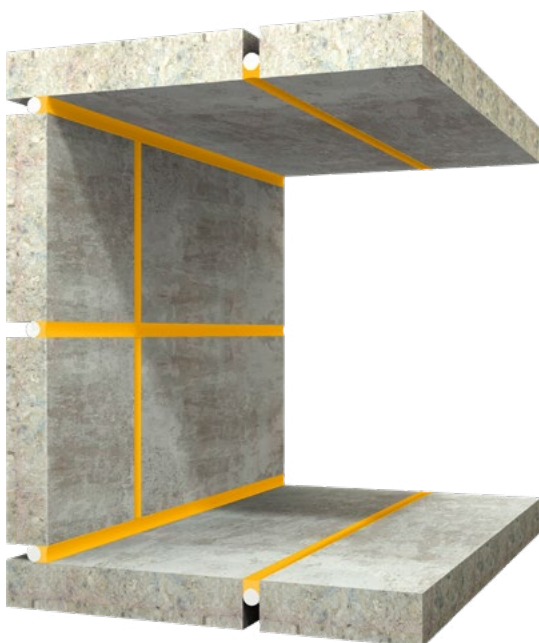

# Sika® Backer Rod Fire

Fire resistant mineral wool based backer rod system for linear seals



## Description

Sika® Backer Rod Fire is a fire resistant, mineral wool based backer rod for interior and exterior joints in walls and floors. Sika® Backer Rod Fire is used in combination with SikaHyflex®-250 Facade, Sikaflex® AT Connection or Sikaflex® PRO-3.

## Uses

Linear seals in fire compartments like stair cases, industrial facilities, warehouses, etc.

Fire resistant joints exposed to chemicals or mechanical impact (in combination with Sikaflex® PRO-3).

## Advantages

Very versatile, can be combined with several joint sealants

Adapts all irregularities of the joint

Up to 4 hours fire resistance

Efficient application from rolls

## Approvals, Certificates

ETA acc. EAD-350141-00-1106

EN 1366-4

EN 13501-2

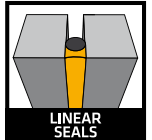

Packaging	Colour	Article Code
12mm x 50m roll	Beige	580869
15mm x 50m roll		580802
20mm x 30m roll		580974
30mm x 30m roll		580976
40mm x 30m roll		580980
50mm x 25m roll		580982
60mm x 25m roll		580985

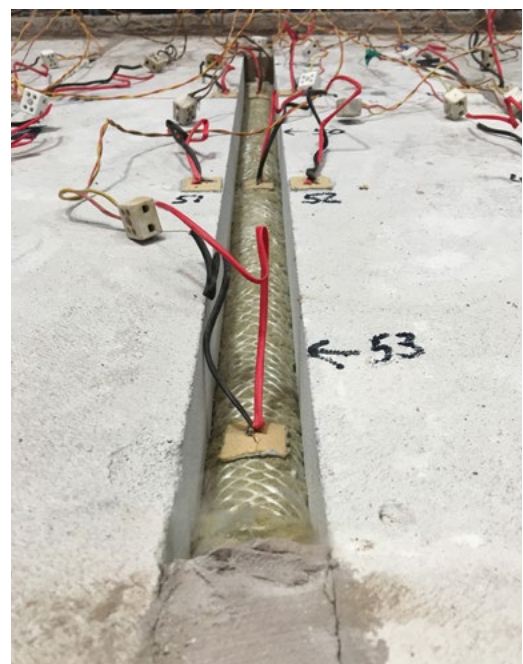
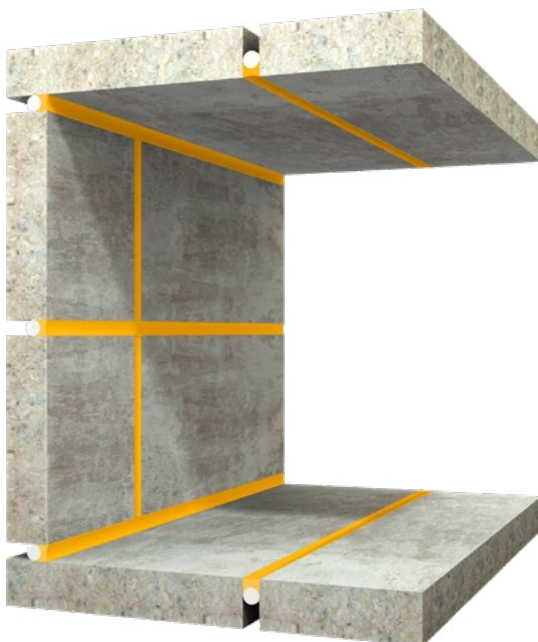



# SikaBoom<sup>®</sup>-420 Fire

Fire resistant PU expanding foam for gun and nozzle application



## Description

Sika Boom<sup>®</sup>-420 Fire is a fire resistant 1-part PU expansion foam for interior joints in walls.

## Uses

Restores the fire resistance performance of a floor or wall which incorporates liner seals  
Interior use only

## Advantages

Fire resistance up to 180 minutes according to EN 1366-4  
Combi-valve for gun or nozzle application  
1-Part ready to use  
Safety valve for extended shelf life  
Cured foam can be cut, trimmed, and sanded

## Approvals, Certificates

ETA acc. EAD-350141-00-1106  
EN 1366-4  
EN 13501-2

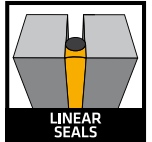

Packaging	Colour	Article Code
750ml tin/ 12 per box	Pink	653648







# SikaSeal®-623 Fire+

Fire resistant intumescent sealant for penetration seals



## Description

SikaSeal®-623 Fire+ is a fire resistant, intumescent graphite sealant. It is used for penetration seals around combustible services in fire compartment walls and floors. In case of fire, SikaSeal®-623 Fire+ closes gaps due to volume expansion of up to 25 times.

## Uses

Restores the fire resistance performance of a wall or a floor which incorporates combustible pipes, combustible pipe insulations or conduits.

## Advantages

- Up to 4 hours fire resistance
- Highly intumescent - volume expansion up to 25 times original size
- 1-part ready to use, easy to apply
- Provides acoustic insulation
- Tested for a large variety of relevant wall and floor types

## Approvals, Certificates

ETA acc. EAD-350454-00-1104  
 EN 1366-3  
 EN 13501-2  
 UL EU  
 Ecode EC1<sup>PLUS</sup>  
 LEED Attestation



Packaging	Colour	Article Code
300 ml Cartridge, 12 pc/box	Anthracite	691260

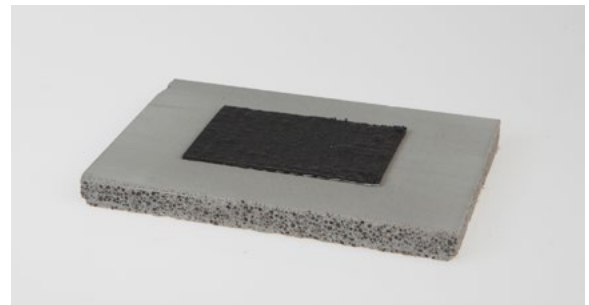

# Sikacryl®-625 Fire+

Fire resistant ablative coating for walls and floors



## Description

Sikacryl®-625 Fire+ is a 1-part fire resistant, ablative acrylic coating used to enhance the fire resistance of mineral fibre boards

## Uses

Covers linear seals up to 120 mm in combination with mineral fibre backing  
Edge coating of SikaSeal®-626 Fire Board+ when installed on the outer face of a wall or floor

## Advantages

Up to 4 hours fire resistance  
1-part ready to use, easy to apply  
Easy to clean

## Approvals, Certificates

ETA acc. EAD-350141-00-1106  
EN 1366-4  
EN 13501-2  
UL EU  
LEED Attestation



Packaging	Colour	Article Code
3L pail	White	696866

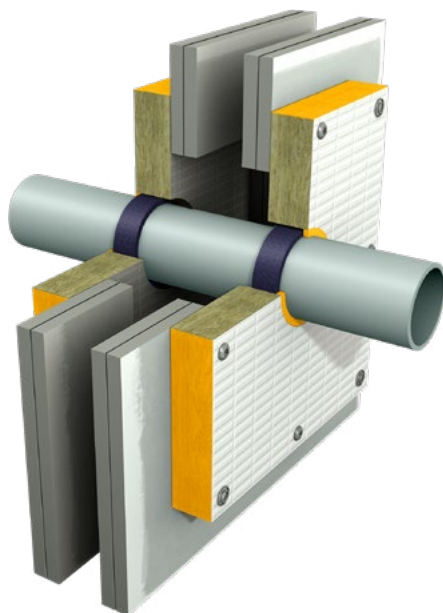



# SikaSeal<sup>®</sup>-626 Fire Board+

Fire resistant coated protection board

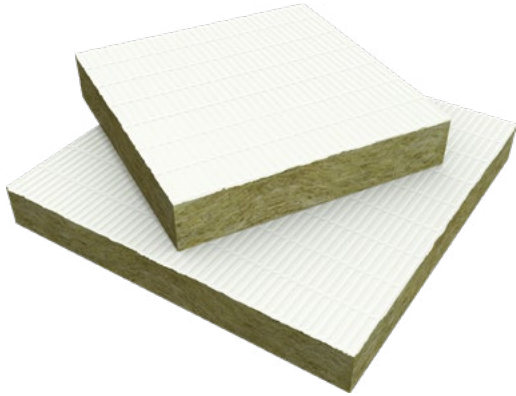

## Description

SikaSeal<sup>®</sup>-626 Fire Board+ is a mineral wool-based protection board coated with the fire resistant, ablative coating Sikacryl<sup>®</sup>-625 Fire+. Can be combined with many other Sika passive fire protection products for sealing a wide range of service penetrations.

## Uses

Restores the fire resistance performance of walls and floors which incorporate single and multiple service penetrations

Can be combined with Sikacryl<sup>®</sup>-621 Fire+, Sikacryl<sup>®</sup>-625 Fire+, SikaSeal<sup>®</sup>-627 Fire Collar+ and SikaSeal<sup>®</sup>-629 Fire Wrap+

## Advantages

- Up to 4 hours fire resistance
- Easy to install, no need for specialist tools
- For face-fit (pattress-fit) and internal-fit installations
- Provides acoustic insulation
- Tested for a large variety of relevant wall and floor types

## Approvals, Certificates

ETA acc. EAD-350454-00-1104  
EN 1366-3  
EN 13501-2  
UL EU



Packaging	Colour	Article Code
1200x600x50mm, 30 board per pallet	White coating, green core	691793

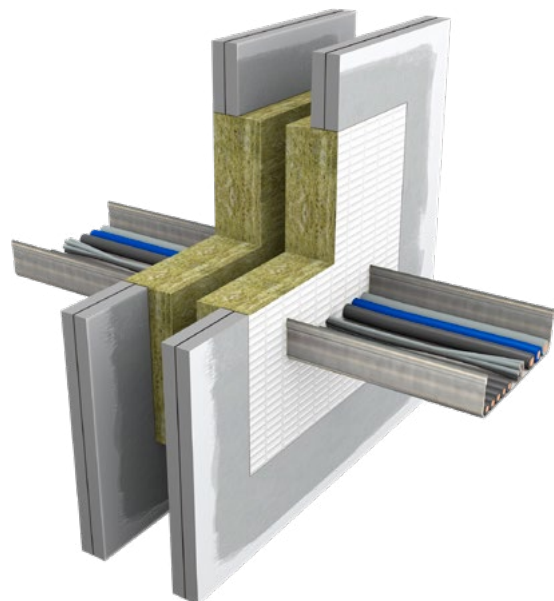
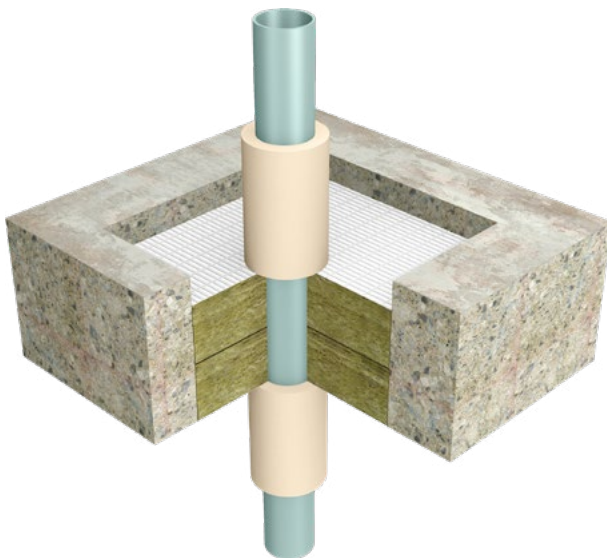

# SikaSeal®-627 Fire Collar+

Fire resistant pipe collar



## Description

SikaSeal®-627 Fire Collar+ is a fire resistant, prefabricated pipe collar consisting of a metal casing and an in-tumescent insert for interior penetration sealing applications. In case of fire, SikaSeal®-627 Fire Collar+ closes gaps due to volume expansion of up to 17 times.

## Uses

Restores the fire resistance performance of a wall or a floor which incorporates combustible pipes, combustible pipe insulations or conduits.

Can be combined with Sikacryl®-621 Fire+ and SikaSeal®-626 Fire Board+

## Advantages

- Up to 4 hours fire resistance
- Highly intumescent - volume expansion up to 17 times original size
- Large pipe range covered
- Tested for a large variety of relevant wall and floor types

## Approvals, Certificates

ETA acc. EAD-350454-00-1104  
EN 1366-3  
EN 13501-2  
UL EU



Packaging	Colour	Article Code
32mm, 2pcs per box	White metal casing, anthracite insert	698157
40mm, 2pcs per box		698244
55mm, 2pcs per box		698212
63mm, 2pcs per box		698213
75mm, 2pcs per box		698214
82mm, 2pcs per box		698253
90mm, 2pcs per box		698231
110mm, 2pcs per box		698254
125mm, 2pcs per box		698245
140mm, 2pcs per box		698246
160mm, 2pcs per box		698247
200mm, 2pcs per box		698248
250mm, 2pcs per box		698249

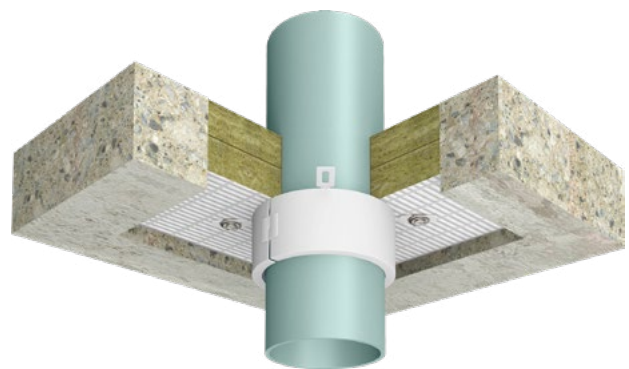
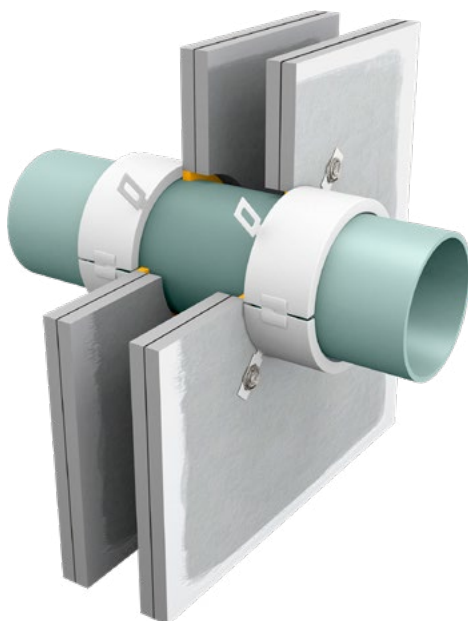



# SikaSeal®-629 Fire Wrap+

Fire resistant pipe wrap



## Description

SikaSeal®-629 Fire Wrap+ is a fire resistant, flexible pipe wrap available as pre-cut strips or on a roll. In case of fire, SikaSeal®-629 Fire Wrap+ closes gaps due to volume expansion of up to 28 times.

## Uses

Restores the fire resistance performance of a wall or a floor which incorporates combustible pipes, combustible pipe insulations or conduits.

Can be combined with Sikacryl®-621 Fire+, SikaSeal®-626 Fire Board+ and Sikacrete®-630 Fire+

## Advantages

- Up to 4 hours fire resistance
- Highly intumescent - Volume expansion 28 times original size
- Invisible installation in walls and floors
- Wide pipe range covered
- Tested for a large variety of wall and floor types

## Approvals, Certificates

ETA acc. EAD-350454-00-1104  
EN 1366-3  
EN 13501-2  
UL EU



Packaging	Colour	Article Code
50mm x 25m 1 roll per box	Anthracite	698158
55mm 30 wraps per box		698737
82mm 40 wraps per box		698913
110mm 40 wraps per box		698912
125mm 40 wraps per box		698914
160mm 20 wraps per box		698915
200mm 7 wraps per box		698916

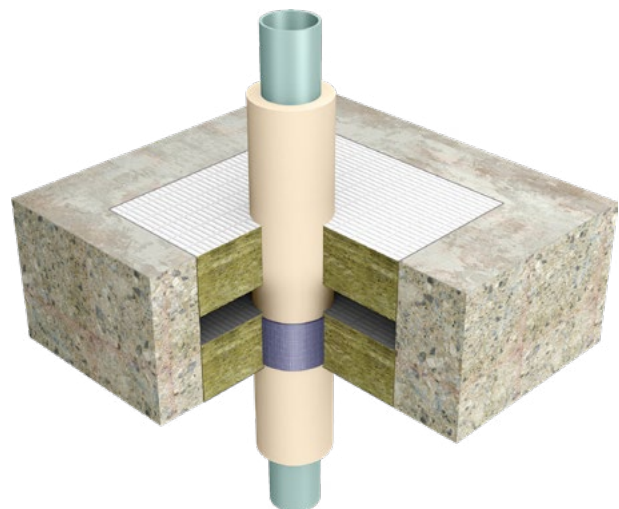
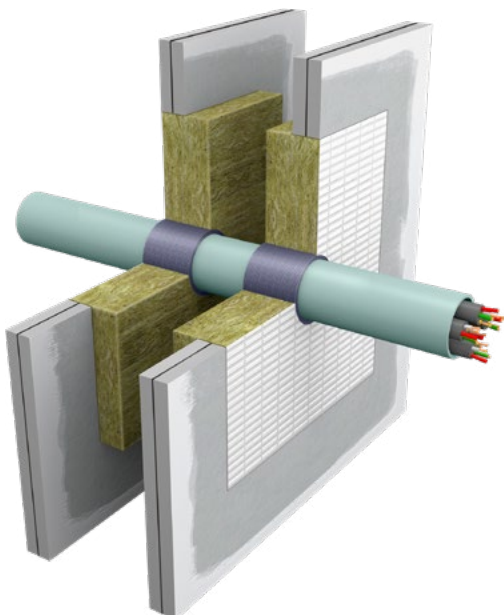

# Sikacrete®-630 Fire+

Fire resistant load bearing compound



## Description

Sikacrete®-630 Fire+ is a non-combustible gypsum-based compound, used for load bearing penetration seals in fire compartment floors.

## Uses

Restores the fire resistance performance of a floor which incorporates a large variety of service penetrations such as cables, cable trays, metal pipes and plastic pipes. Can be combined with SikaSeal®-629 Fire Wrap+.

## Advantages

- Up to 4 hours fire resistance
- 1-part easy to mix, easy to apply
- Pourable and trowelable application
- Self-supporting in floor penetrations
- Very fast setting, no loss of volume
- Load bearing
- Provides acoustic isolation

## Approvals, Certificates

ETA acc. EAD-350454-00-1104  
 EN 1366-3  
 EN 13501-2  
 UL EU  
 Emericode EC1<sup>PLUS</sup>  
 LEED Attestation



Packaging	Colour	Article Code
15kg bag	Light grey	691802

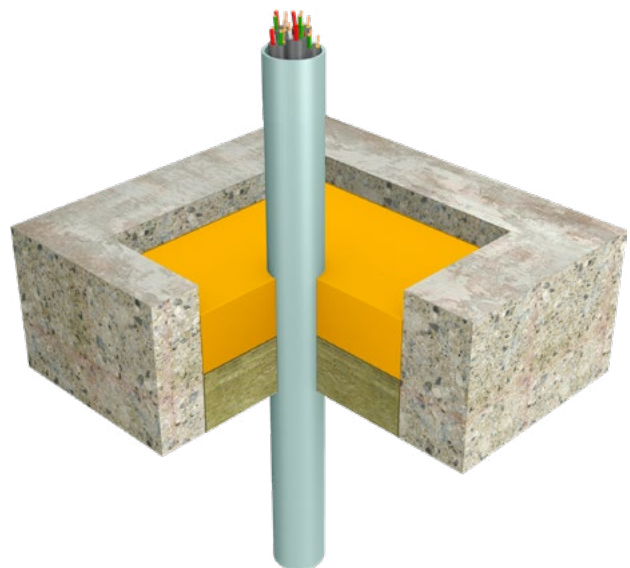



# SikaSeal®-632 Fire Putty+

Fire resistant putty



## Description

SikaSeal®-632 Fire Putty+ is a fire-resistant sealing putty used for small openings around services in fire compartment walls and floors.

## Uses

Restores the fire resistance performance of a wall or a floor which incorporates small service openings containing cables, insulated and uninsulated metal pipes.

Suitable for small gaps around services where sealants cannot be applied to the required depth.

## Advantages

- Up to 4 hours fire resistance
- Easy to apply, hand workable
- Cord is fitted to cover the gap around a service, no need to fill the gap
- Tested for a large variety of relevant wall and floor types

## Approvals, Certificates

ETA acc. EAD-350454-00-1104  
 EN 1366-3  
 EN 13501-2  
 UL EU  
 Emicode EC1<sup>PLUS</sup>



Packaging	Colour	Article Code
Display box with 5 pieces, 20 boxes per outer	Red	697099

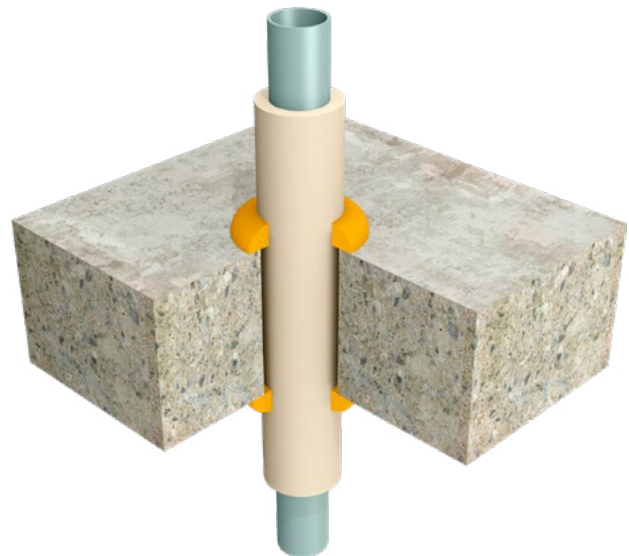
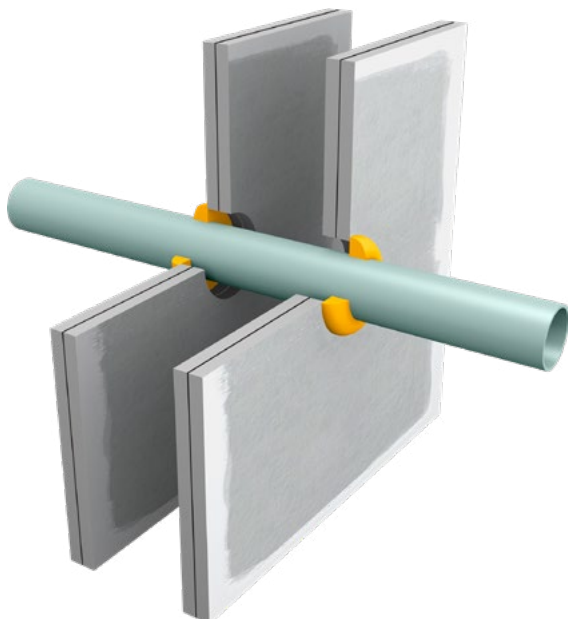

# Firespan Ablative Pads

Pads for inside or outside of electrical back boxes



**Single Pad**

## Description

Designed to be used on the inside or outside of electrical back boxes to maintain fire and smoke barrier where service holes are cut into dry lining and all types of fire rated boarding.

## Uses

- To provide up to 2 hours fire protection
- Maintain acoustic integrity of the drylining system

## Advantages

- High tack adhesion
- Pliable and mouldable
- Self bonding

## Approvals, Certificates

- EN 1366-3
- BS EN ISO 140/3
- EN 13141-1

Packaging	Colour	Article Code
Single 4mm x 170mm x 170mm	Red	486164
Double 4mm x 230mm x 170mm	Red	486165

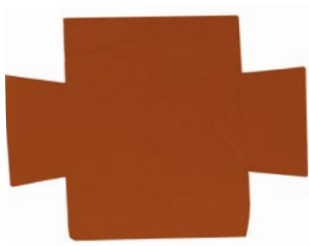

**Double Pad**







# SIKA AS A SOLUTION PROVIDER

Passive fire protection requires more than compartmentalisation in buildings

As shown in the previous pages, Sika provides a full range of passive fire protection products and integrated systems for the building industry. The philosophy behind these and all such fire protection products is to isolate any outbreak of fire at an early stage, and thereby to contain this fire within a so called fire-compartment, which prevents the fire spreading further around the building.

The same approach is followed by Emseal – a Sika company – with their products, which are shown on following pages. In addition to products used to create fire-compartments, there are numerous other applications relating to fire resistance and for many of these, Sika also has a high level of expertise and experience, particularly in providing integrated proven system solutions.

On the following pages there is an overview of some of these additional Sika passive fire protection solutions.





# Sikacrete®-213 F

Fire protection mortar for tunnels and other civil engineering or building structures

In a fire the load bearing elements of a structure can very quickly be exposed to temperatures which are high enough to cause severe damage and significant loss of strength – in the worst case – collapse of the element or even the whole building structure.

In tunnels especially, a fire can cause the temperatures to rise extremely fast because the heat cannot escape, and as a result the vapour pressures in the concrete can lead to explosive spalling and other severe damage. Sikacrete®-213 F is a fire resistant, spray applied mortar system which effectively protects concrete and structures from such destructive forces.

Sikacrete®-213 F has another big advantage in that it can provide this high level of protection in thin layers, as proven in fire testing in accordance with the RWS temperature curve up to 1,350°C up to 120 minutes with only 26 mm thick layer. The application of Sikacrete®-213 F is by traditional thin layer, wet-spray techniques, generally using typical bonding bridge / adhesion promoter like Sika MonoTop®-910 N. Sikacrete®-213 F can be applied fine enough so it does not require an additional resurfacing mortar in some situations (e.g. if protective coating is to be applied). In tunnel applications when a protective coating is to be applied to

increase the resistance to the cleaning procedure, a pore sealer must be applied to Sikacrete®-213 F prior to placing Sikagard® WallCoat T water-based epoxy coating.

Sikacrete®-213 F is classified as light weight rendering mortar as per EN 998-1, suitable for internal and external applications and it can also – using specific application methods – be used in tunnelling.

Sikacrete®-213 F is also certified by UL to protect concrete structures such as beam and columns, strengthened with Fibre reinforced polymer (glass or carbon) Sika® Carbodur® or SikaWrap®.

## Advantages

- Suitable for interior and exterior applications
- Low coating thickness
- Minimised material consumption
- High fire resistance
- Fast application
- Easy to tool and profile
- Tested acc. RWS, ISO 834 & Lachenbrand temperature curves
- UL Certified for beam & column strengthened with FRP
- Conforms to EN 998-1



# EMSEAL Emshield WFR

Fire resistant, watertight vertical wall expansion joint system

EMSEAL's Emshield WFR Fire resistant wall expansion joint is a dual-sided primary seal for repair, retrofit, and new installation in structural expansion joints and construction joints in vertical plane wall and head-of-wall applications. It provides a fire-rated watertight seal that also maintains the wall's thermal and acoustic capacity.

Each piece is custom made to fit in expansion gap widths up to 100 mm. Emshield WFR features water-repellant silicone sealing surfaces adhered to a fire-retardant impregnated foam backing. The symmetrical design allows either side to face out from an exterior or interior wall and maintain a fire resistance up to 4 hours. The facing surfaces are available in many industry-standard colors.

This single-unit expansion joint system installs easily and rapidly. Held in place by the backpressure of the expanding foam, it eliminates any invasive mounting mechanical elements thereby preserving the integrity of the wall. Continuity of seal for fire resistance, water and air seal, thermal barrier and acoustic is achieved with EMSEAL Universal-90 transitions.

Emshield WFR holds an ETA acc. EAD-350141-00-1106 and is CE marked in conformance to EU safety, health and environmental protection requirements. It has been certified up to 4 hours fire resistance in accordance with EN 1366-4 including  $\pm 50\%$  joint movement as well as EN 12154 and EN 12155 with no leakage with up to 1200 Pa of pressure. It also meets the requirements of ASTM E1966, ASTM E119 and ASTM E1399 and has been tested in accordance with UL/ULC 2079.





# EMSEAL Emshield DFR

Fire resistant, watertight trafficable horizontal deck expansion joint system

EMSEAL's Emshield DFR fire resistant wall expansion joint is a dual-sided primary seal for repair, retrofit, and new installation in structural expansion joints and construction joints in horizontal plane deck and floor applications. It provides a fire resistant watertight seal that also maintains the deck's acoustic and thermal capacity.

Each piece is custom made to fit in expansion gap widths up to 100 mm. Emshield DFR features traffic-grade water-repellant silicone sealing surfaces adhered to a fire-retardant impregnated foam backing. Its fuel-resistant surface supports both vehicular and pedestrian traffic and maintains a fire resistance up to 4 hours.

This single-unit expansion joint installs easily and rapidly. Held in place by the backpressure of the expanding foam, it eliminates any invasive mounting mechanical elements thereby preserving the integrity of the wall.

Continuity of seal, fire resistance, water and air seal, thermal barrier and acoustic achieved with EMSEAL Universal-90 transitions.

Emshield DFR holds an ETA acc. EAD-350141-00-1106 and is CE marked in conformance to EU safety, health and environmental protection requirements. It has been certified up to 4 hours fire rating in accordance with EN 1366-4 testing as well as EN 12154 and EN 12155 with no leakage with up to 1200 Pa of pressure. It also meets the requirements of ASTM E1966, ASTM E119 and ASTM E1399 and has been tested in accordance with UL/ULC 2079.









# SIKA FULL RANGE SOLUTIONS FOR CONSTRUCTION:



LIQUID APPLIED ROOFING



SINGLE PLY ROOFING

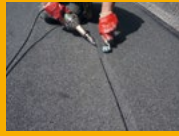

BITUMINOUS ROOFING



CONCRETE



CONCRETE REPAIR



STRUCTURAL STRENGTHENING



BUILDING FINISHING



WATERPROOFING



JOINT SEALING



FAÇADES



FLOORING



INDUSTRY



DISTRIBUTION



BUILDING TRUST

## WHO WE ARE

Sika Limited and Sika Ireland Limited are part of the global Sika Group, specialising in the manufacture and supply of chemical based products. Sika has a leading position in the development and production of systems and products for bonding, sealing, damping, reinforcing, and protecting in the building sector and the motor vehicle industry. Sika has subsidiaries in 100 countries around the world and manufactures in over 300 factories. With more than 25,000 employees Sika generates annual sales of CHF 7.9 billion (£6.14 bn). We are also committed to providing quality, service, safety and environmental care.

In the UK and Ireland, we provide market-leading solutions for concrete, waterproofing, roofing, flooring, refurbishment, sealing & bonding, and industry, and have manufacturing sites in Welwyn Garden City, Preston, Leeds, Wishaw and Dublin with more than 920 employees and a turnover of more than £290 million.

The information, and, in particular, the recommendations relating to the application and end use of Sika® products, are given in good faith based on Sika's current knowledge and experience of the products when properly stored, handled and applied under normal conditions. In practice, the differences in materials, substrates and actual site conditions are such that no warranty in respect of merchantability or of fitness for a particular purpose, nor any liability arising out of any legal relationship whatsoever, can be inferred either from this information, or from any written recommendations, or from any other advice offered. The proprietary rights of third parties must be observed. Please refer to our homepage [www.sika.ie](http://www.sika.ie) for our current standard terms & conditions applicable to all orders. Users should always refer to the most recent issue of the Product Data Sheet for the product concerned, copies of which will be supplied on request.



## SIKA IRELAND LIMITED

Sika House  
Ballymun Industrial Estate  
Dublin 11  
D11 DA2V  
Ireland

## Contact

Phone +353 1 862 0709  
Fax +353 1 862 0707  
E-Mail [info@ie.sika.com](mailto:info@ie.sika.com)  
[www.sika.ie](http://www.sika.ie)  
@SikaIreland

BUILDING TRUST

